



HVAC/R REFRIGERANT ANALYZER

OPERATION MANUAL

Analyzer Part Number: 68940



Table of Contents

| | |
|---|-----------|
| FOR YOUR SAFETY | 3 |
| ANALYZER WARNINGS | 3 |
| GENERAL CAUTIONS | 4 |
| WELCOME | 5 |
| 1 INTRODUCTION AND OVERVIEW | 6 |
| 1.1 GENERAL | 6 |
| 1.2 FEATURES | 7 |
| 1.3 COMPONENTS | 8 |
| 68940 Base Unit | 8 |
| Low Side Vapor Sample Hose | 8 |
| High Side Liquid Sample Hose | 9 |
| AC Power Adapter | 9 |
| Control Panel | 10 |
| Back Panel Connections | 10 |
| Hard Shell Storage/Carrying Case | 11 |
| 2 YELLOW JACKET 68940 OPERATION | 12 |
| 2.1 FIRST USE | 12 |
| 2.2 TURNING ON THE UNIT | 12 |
| 2.3 CALIBRATION | 13 |
| 2.4 VAPOR SAMPLING | 14 |
| 2.5 LIQUID SAMPLING | 15 |
| 2.6 VIEWING THE TEST RESULTS | 15 |
| 2.7 CONTAMINATED BLEND REFRIGERANTS | 16 |
| 2.8 PURE BLEND REFRIGERANTS | 16 |
| 2.9 PURE BLENDS WITH INCORRECT COMPONENT RATIOS | 17 |
| 2.10 MEASURING AIR | 17 |
| 2.11 PRINTING THE TEST RESULTS & CHANNEL DATA | 18 |
| 2.12 CHANNEL DATA MODELLING | 19 |
| 3 MAINTENANCE & TROUBLESHOOTING | 20 |
| 3.1 SETTING THE LCD CONTRAST | 20 |
| 3.2 CHANGING THE WHITE PLASTIC SAMPLE FILTER | 20 |
| 3.3 REPLACING THE BRASS SAMPLE HOSE RESTRICTOR | 21 |
| 3.4 CHANGING THE PRINTER PAPER | 21 |
| 3.5 SOFTWARE UPDATE | 22 |
| 3.6 LOW BATTERY WARNING | 23 |
| 3.7 AIR SENSOR LOW | 23 |
| 3.8 ERROR MESSAGE | 23 |
| APPENDICES | 24 |
| 3.9 SPARE PARTS LIST | 24 |
| 3.10 APPENDIX B – SPECIFICATIONS | 24 |



For Your Safety:

PLEASE READ THIS MANUAL IN ITS ENTIRETY BEFORE ATTEMPTING INSTALLATION OR OPERATION! Attempting to operate the *YELLOW JACKET 68940* without fully understanding its features and functions may result in unsafe conditions.

Analyzer Warnings

- **REFRIGERANT BLEND WARNING:** The HVAC industry is ever evolving new refrigerants. Many of these new blends can be identified and/or profiled using the YELLOW JACKET 68940.
- **SAMPLE FILTER WARNING:** Replace the sample filter of the instrument *AS SOON AS RED SPOTS OR DISCOLORATION BEGIN TO APPEAR ON THE OUTSIDE DIAMETER OF THE WHITE ELEMENT*. Failure to properly maintain and replace the sample filter will result in severe damage or inaccurate results.
- **SAMPLE INPUT WARNING:** The instrument includes sampling options. One for High Side Liquid sampling and one for Low Side Vapor Sampling. Failure to use the correct hose configuration on the proper sample port may result in incorrect readings and/or damage to the instrument. *DO NOT* attempt to introduce liquid or samples heavily laden with oil into the Low Side sampling hose configuration. Damage caused to the instrument due to the use of the wrong hose configuration on the wrong port will void the warranty!
- **BATTERY CHARGING WARNING:** When charging the internal battery with the supplied power supply, the power supply may become warm. If the power supply becomes warm, unplug the immediately! When charging multiple analyzers, allow the charger to cool between each battery.

General Cautions



- **ALWAYS** wear eye and skin protection when working with refrigerants. Escaping refrigerant vapors will present a freezing danger.
- **ALWAYS** turn the compressor *OFF* before connecting the instrument to an air conditioning system.



- **ALWAYS** inspect the sample hose before each use. Replace the hose if it appears cracked, frayed, obstructed or fouled with oil.
- **DO NOT** direct refrigerant vapors venting from hoses towards the skin.



- **DO NOT** disassemble the instrument. There are no serviceable components internal to the instrument and disassembly will void the warranty.
- **ALWAYS** place the Analyzer on a flat and sturdy surface.
- To reduce the risk of electrical shock, do not disassemble the instrument; do not use the instrument in wet or damp areas.
- Some systems may contain hydrocarbons or flammable refrigerants. This analyzer is designed with sealed heat sources and without sparking components. Ensure adequate ventilation and always take proper precautions when working with refrigerants.



- **DO NOT** breathe refrigerant and lubricant vapor or mist. Exposure may irritate eyes, nose, and throat. If accidental system discharge occurs, immediately ventilate the work area.



- **DO NOT** utilize any hose assembly other than those supplied with the instrument. The use of other hose types will introduce errors into the refrigerant analysis and instrument calibration.
- **ALWAYS** verify that the refrigerant which is tested from the Low Side does not contain or will not emit heavy loads of oil or liquid.



- **NEVER** admit any sample into the instrument at pressures in excess of *500 psig*.
- **NEVER** obstruct the air intake, sample exhaust or case ventilation ports of the instrument during use.

WELCOME

Thank you for purchasing the YELLOW JACKET 68940 Refrigerant Identifier.

The *YELLOW JACKET 68940 Refrigerant Identifier* is the most advanced refrigerant analyzer ever designed for determining the purity of common gaseous refrigerants. It has many features to offer the user, which will be described in this manual. We recommend that all personnel who use this instrument read this manual to become more familiar with its proper operation.

For further information regarding the application, operation or spare parts, please contact the Ritchie Engineering Co., Inc. Customer Service Department. If you have questions or comments, we would like to hear from you.

Ritchie Engineering – YELLOW JACKET Products Division
10950 Hampshire Avenue South
Bloomington, MN 55438, USA
Tel: (952) 943-1300

Contact us: custserv@yellowjacket.com
Visit us: www.yellowjacket.com

1

INTRODUCTION AND OVERVIEW

1.1 General

Contamination and mislabelling of refrigerants either in storage cylinders or air conditioning systems can lead to component corrosion, elevated head pressures and system failures when utilized by unsuspecting technicians. The ability of the technician to determine refrigerant type and purity is severely hampered by the presence of air when attempting to utilize temperature-pressure relations. The development of various substitute refrigerants further complicates the ability of a technician to identify refrigerant purity based upon temperature-pressure relationships. The substitute refrigerant blends can also introduce a flammability hazard to the technician and the ultimate end user of the air conditioning system.

The YELLOW JACKET 68940 Refrigerant Analyzer provides a *fast, easy and accurate* means to determine refrigerant purity in refrigerant storage cylinders or directly in air conditioning systems. The instrument utilizes non-dispersive infrared (NDIR) technology to determine the weight concentrations of multiple refrigerant types. Refrigerant purity is displayed on the LCD Screen and the user must determine acceptable levels of purity based on their recovery or use standards.

The instrument is supplied complete with a ¼" Flare Vapor Sampling Hose, a High Pressure Liquid Sample Trap Assembly, a 100-240 VAC power transformer, built in Lithium Iron Phosphate battery, thermal printer, and all required plumbing housed within a rugged, portable, storage case.

Testing occurs when sample gas is admitted into the instrument through the supplied sampling hose configurations and presented to the sensing device. The instrument provides the user with direct *percent by weight* concentrations.

The instrument interfaces with the user via a LCD graphic display, status indicator LED's, and push button communication switches. Direct *percent by weight* concentrations of the sampled refrigerant are provided on the display as well as user directions and prompts. An on-board printer is provided to print an on-the-spot analysis report.

The YELLOW JACKET 68940 Refrigerant Analyzer Refrigerant Analyzer provides the refrigerant technician with *excellent* knowledge of refrigerant type and purity as well as protection against refrigerant contamination and potential flammability.

1.2 Features

The YELLOW JACKET 68940 Refrigerant Analyzer is the **MOST** advanced portable instrument ever manufactured for determining the purity of gaseous refrigerants for the HVAC-R market.

Features Include:

- Advanced ergonomic design
- Rugged rubberized hand grips
- Large graphic display with on-screen instructions
- Fast test time
- Built in printer for instant analysis report
- Built in oxygen sensor to detect presence of Air
- Vapor or Liquid Sampling ability
- Internal, rechargeable Lithium Iron Phosphate battery for cordless operation in any location
- Hard shell carry/storage case
- USB Port for Remote Software Updates

1.3

YELLOW JACKET 68940 Components

Base Unit

The YELLOW JACKET 68940 Refrigerant Analyzer base unit houses the Graphic Display, Infrared Bench, Electrical Connections, built in Lithium Iron Phosphate Battery and Printer Module. **These components require no maintenance; therefore, there are no serviceable components internal to the instrument. Disassembly will void the warranty.**

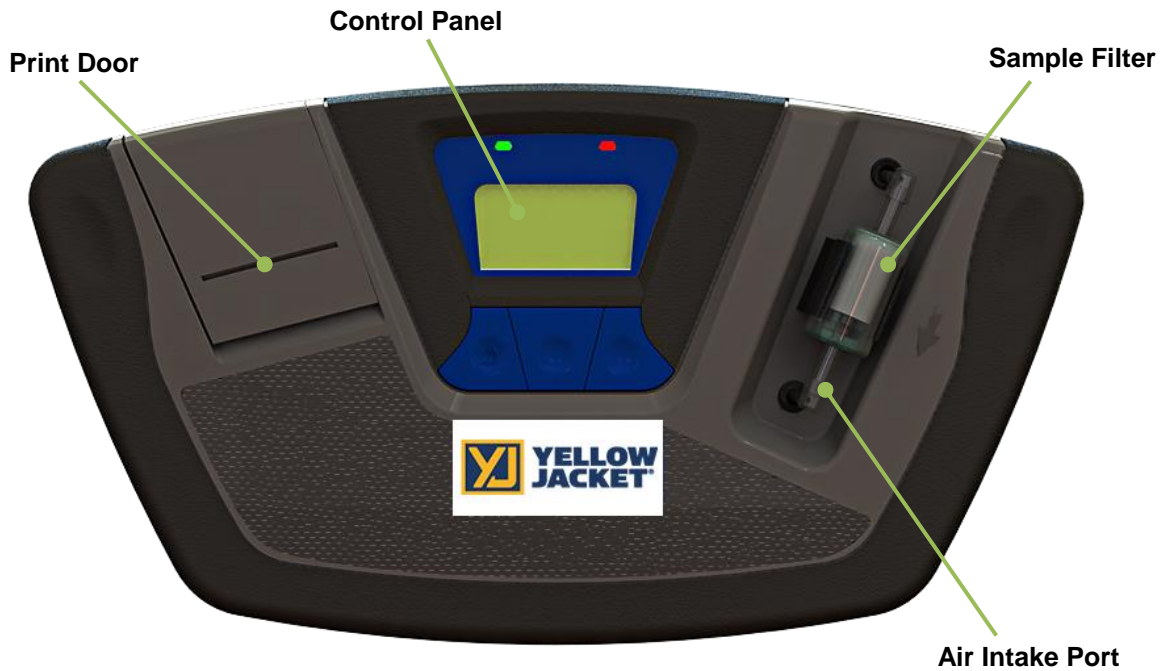

Low Side Vapor Sample Hose

The 6.5 foot (2 meter) Low Side Vapor Sample Hose configuration is constructed of a polyurethane tube. A Brass Sample Hose Restrictor acts to reduce pressure at the sample connection point and reduce the introduction of harmful oil into the machine. The maximum inlet pressure is 500 psig. The hose is provided with an instrument inlet port mating connector on one end and a 1/4" SAE female flare coupling nut on the service end.

NOTE: The analyzer will indicate "Non-Condensable" or "Unknown Refrigerant" if the analyzer does not receive a good sample due to obstructed flow or lack of flow. If this occurs the Brass Sample Hose Restrictor may need to be replaced.

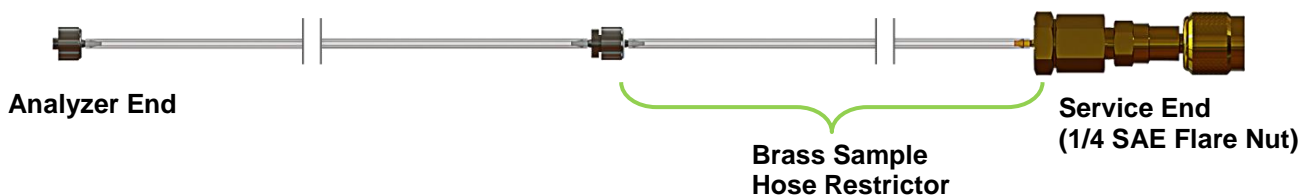

High Side Liquid Sample Hose

The 6.5 foot (2 meter) High Side Sample Hose configuration is constructed of a polyurethane tube with an oil reservoir. A Brass Sample Hose Restrictor acts to transform Liquid refrigerant to Vapor at the sample connection point while the High Pressure Liquid Sample Trap Assembly collects oil and provides a means of expulsion after the test is complete. The syringe is provided with a magnet for attaching it to the tank, an instrument inlet port mating connector on one end and a 1/4" SAE female flare coupling nut on the service end. The maximum pressure is 500 psig.

NOTE: The analyzer will indicate "Non-Condensable" or "Unknown Refrigerant" if the analyzer does not receive a good sample due to obstructed flow or lack of flow. If this occurs the Brass Sample Hose Restrictor may need to be replaced.

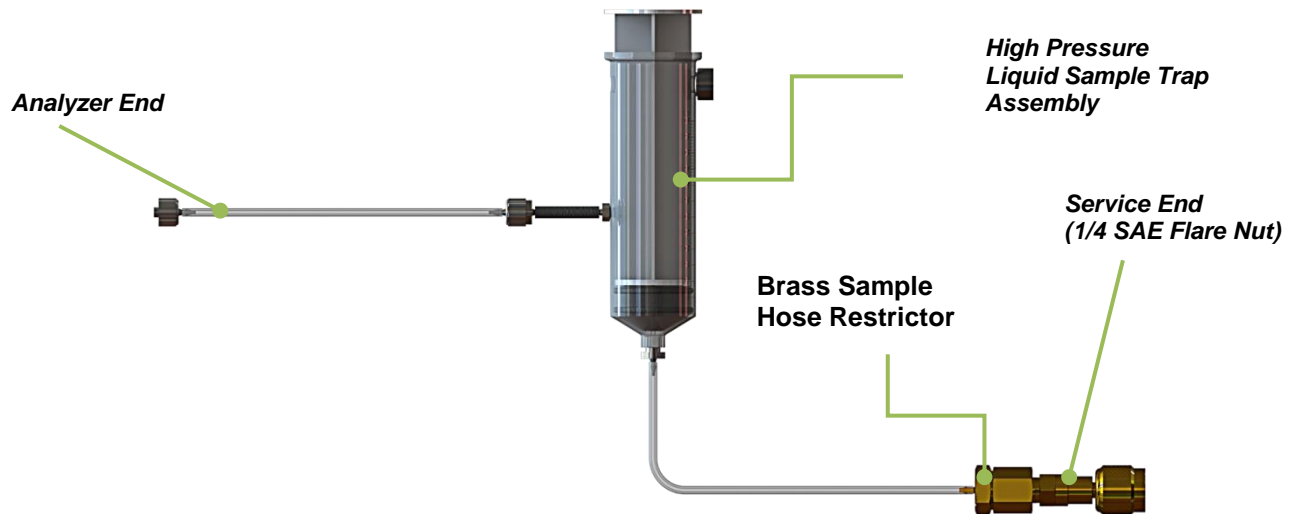

AC Power Adapter

The YELLOW JACKET 68940 is powered via a Lithium Iron Phosphate battery. You can also power the unit via the 90-264 VAC, 50-60 Hz power transformer. This transformer is included with each unit and converts a standard 100-240VAC 50/60Hz wall outlet to 12VDC, 2.0A, which powers the device. This AC Power Adapter will also charge the battery when connected to the analyzer.

NOTE: Use of any other power source may cause damage to the unit and void the warranty.

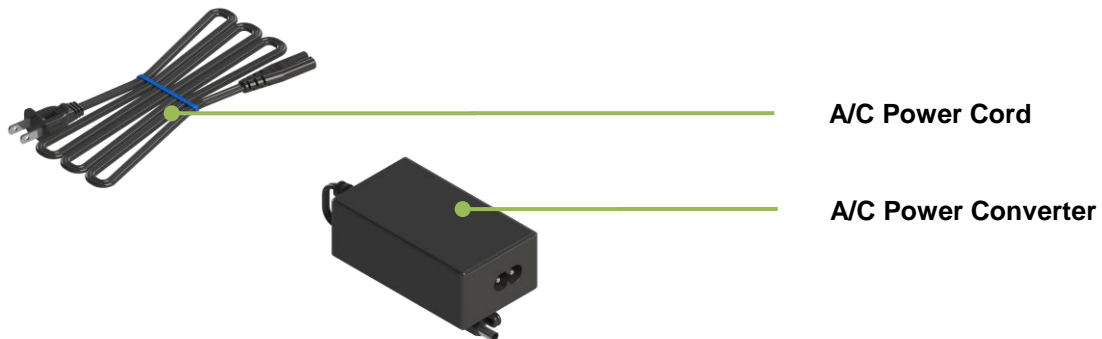

Control Panel

The Control Panel serves as the main user interface. The Control Panel features three soft key buttons that change their function as the instrument changes modes. The current function for each button is displayed above the Soft Key Buttons on the LCD graphic display. Red and Green LED's at the top of the Control Panel are used for visual status indications.

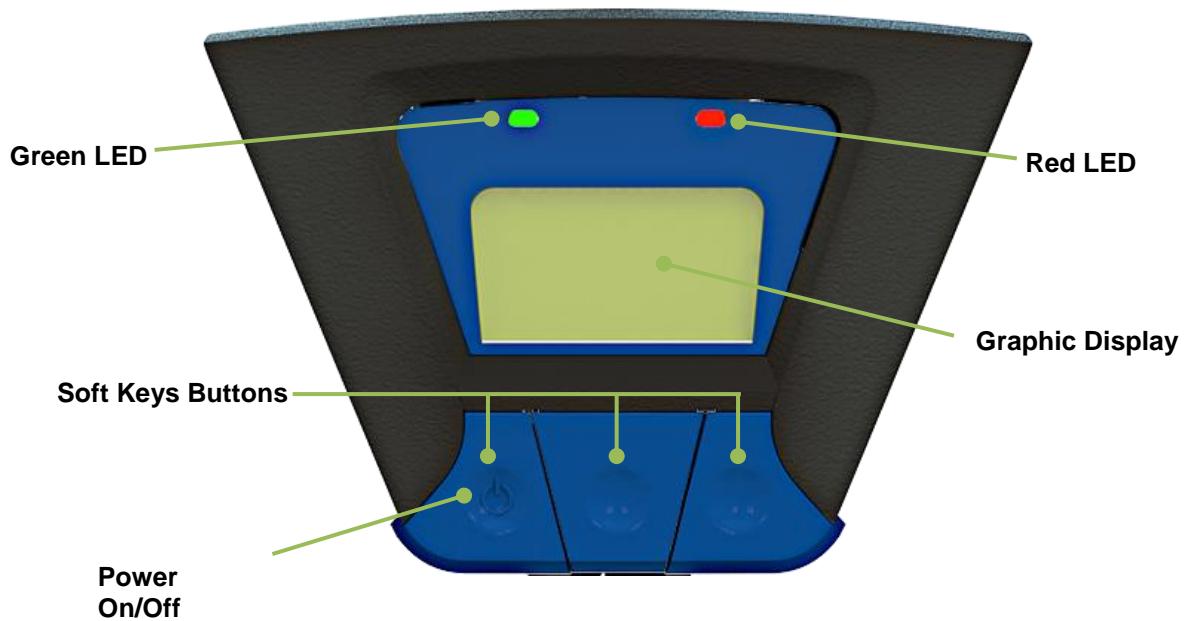

Back Panel Connections

The connections located on the back panel are illustrated below.

CAUTION: The sample outlet port should never be obstructed. Keep the sample outlet port free and clear at all times. Do not operate near open flame.

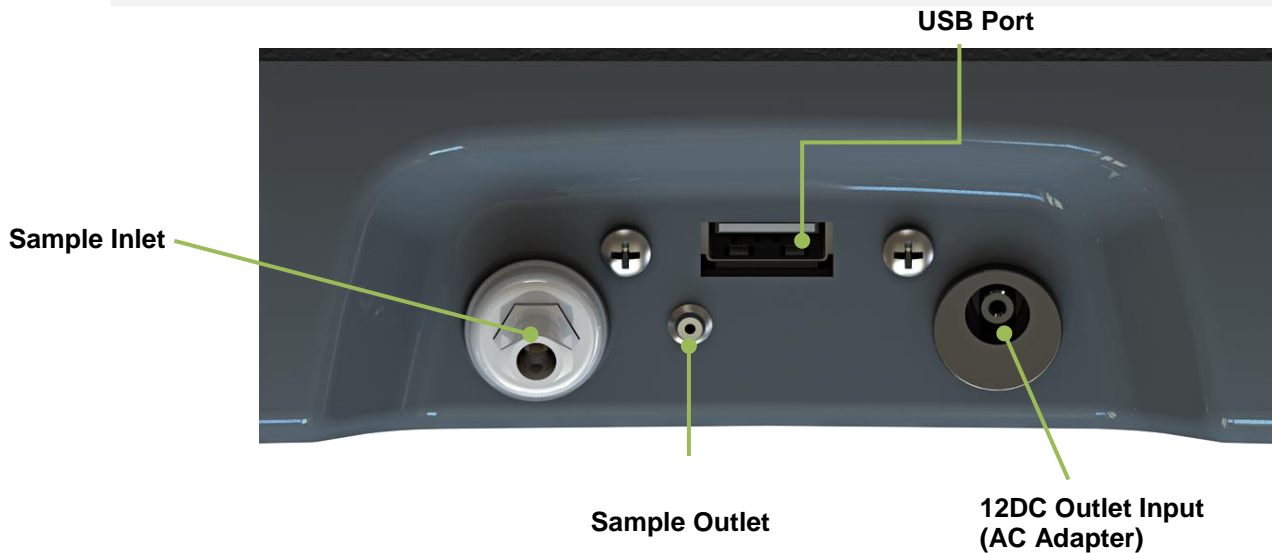

Hard Shell Storage/Carrying Case

The hard shell storage/carrying case is custom fit to the *YELLOW JACKET 68940*. It provides rugged protection for the instrument, as well as convenient storage for all components. The enclosure is general purpose and is *not* watertight.

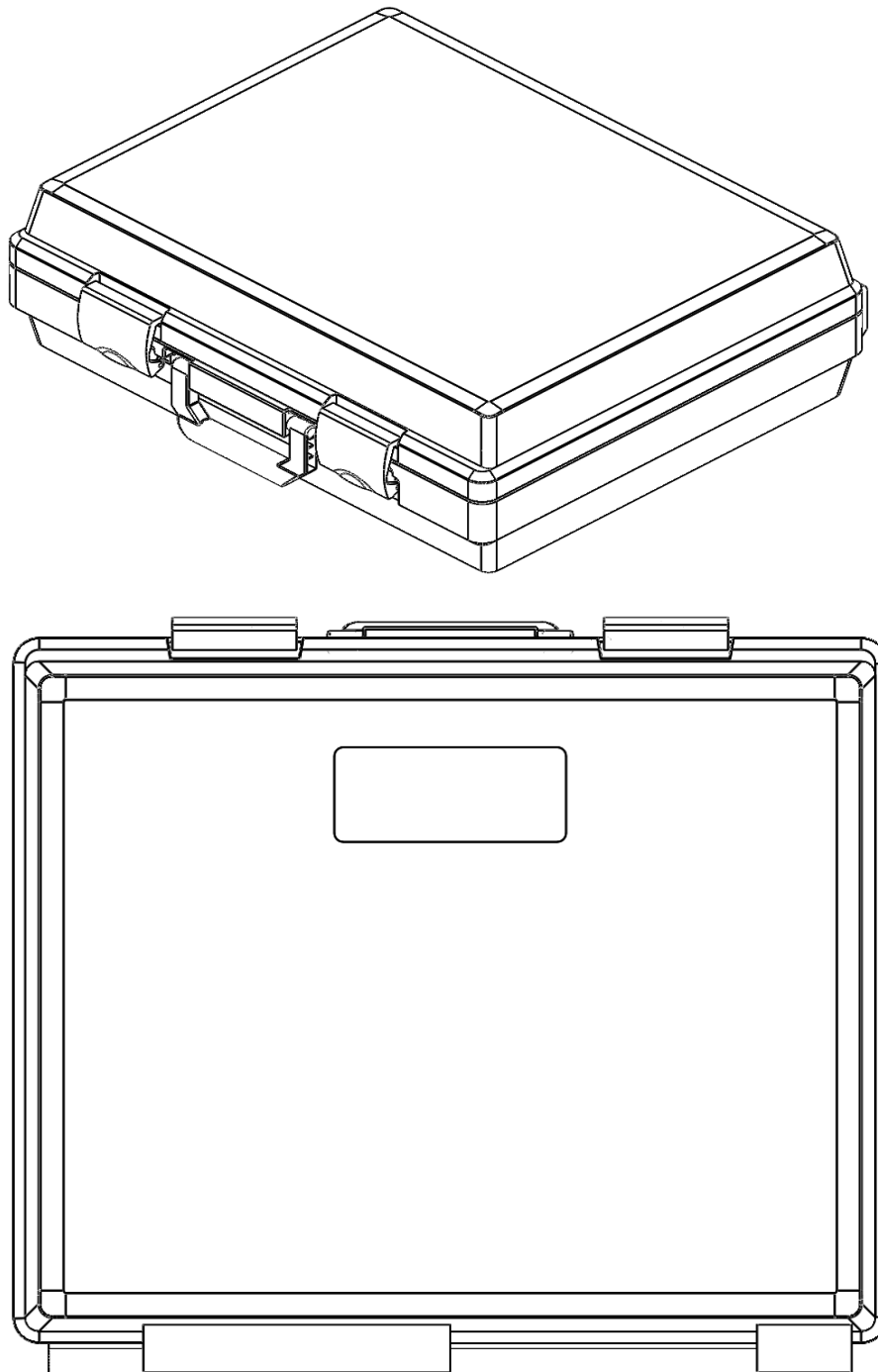

2

YELLOW JACKET 68940 OPERATION

2.1 First Use

The *YELLOW JACKET 68940* has a built in Lithium Iron Phosphate battery. Prior to first use charge the battery for a minimum of 2 hours with the included AC Power Supply. If a power outlet is accessible you may also use the AC Power Supply to power the unit. The analyzer will function and charge the battery while the AC Power Supply is connected.

2.2 Turning On the Unit

Press the left, soft key, 'POWER' button. The splash screen shown in **(Figure 1)** will appear followed immediately by the screen in **(Figure 2)**. If you wish to adjust factory settings press 'SET' and refer to section **3 Maintenance & Troubleshooting**. If you do not need to adjust the settings wait for the screen in **(Figure 3)** to appear. Connect the sample hose to the analyzer and wait approximately 30 seconds for the unit to warm up. Once the analyzer warms up you are ready for Calibration.

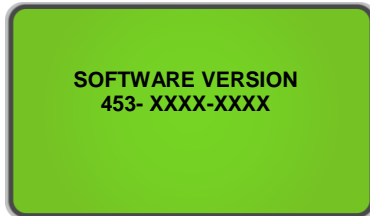

Figure 1

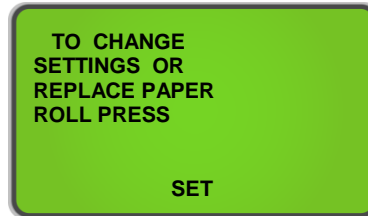

Figure 2

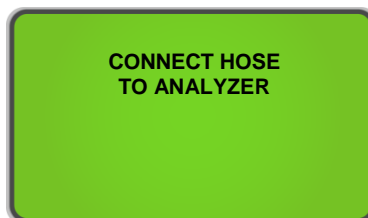

Figure 3

2.3 Calibration

The supplied sample hose needs to be connected to accomplish proper Calibration. Verify the Sampling Hose assembly is connected to the analyzer and making sure it is disconnected from any refrigerant source before Calibration. When you first turn the unit on an Air Calibration will be required; additional Air Calibrations are only required periodically. A reminder to perform air calibrate will appear when needed (**Figure 4**). Press 'CAL' to calibrate the machine. When calibrating, the unit will pull fresh air into the sample cell via an internal pump. This fresh air purges any excess refrigerant and ensures accurate test results. Calibration requires that the sample hose is disconnected from the refrigerant cylinder or air conditioning system and remains connected to the instrument. (**Figure 5**) will display while the Air Calibration is occurring. Calibration will take approximately 130 seconds.

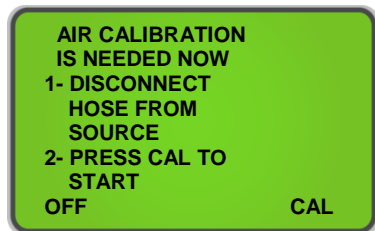

Figure 4

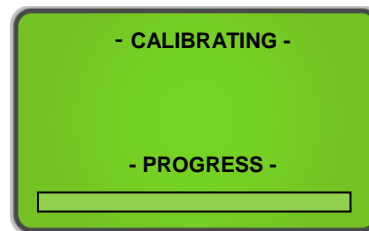

Figure 5

NOTE: In the unlikely event an 'Air Calibration Unstable' message is displayed as shown in (**Figure 6**) verify you are in a ventilate area and there is no gas flowing near the air intake. Once you have verified both parameters, press 'RETRY' to complete another calibration.

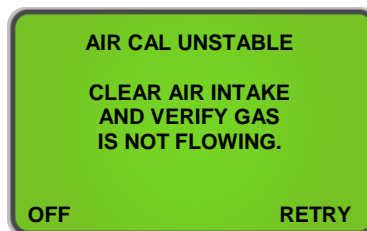

Figure 6

When the unit has completed a successful Air Calibration, the analyzer is then ready for gas testing. The unit will display the screen shown in **(Figure 7)**. Determine if you are Vapor Sampling or Liquid Sampling and make sure the proper hose assembly is connected to complete your required form of testing. Section **2.4 Vapor Sampling** and **2.5 Liquid Sampling** outline proper procedure for both forms of testing.

Connect the hose to the tank or system, open the valve if connecting to a tank, and then press 'TEST'. The *YELLOW JACKET 68940* will display the screen shown in **(Figure 8)**. Before the test is completed the screen in **(Figure 8a)** will appear to indicate the test is nearly complete.

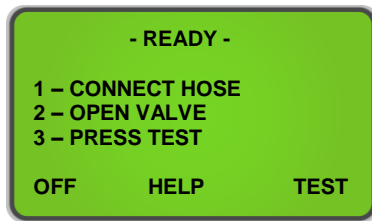

Figure 7

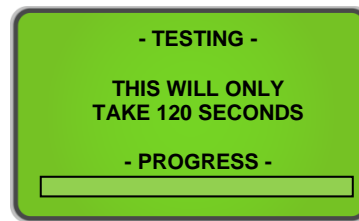

Figure 8



Figure 8a

2.4 Vapor Sampling

Vapor sampling is the most common method used for identifying refrigerants using the *YELLOW JACKET 68940*. It is a simple process requiring the operator to take these 4 steps:

- 1) Connect the Low Pressure Vapor Sampling Hose to the Low Side Vapor port of the system or cylinder.
- 2) Open the low side valve of the cylinder and press 'TEST' **(Figure 7)**.
- 3) When the test is complete, close the low side valve of the cylinder and disconnect the hose from the cylinder.
- 4) Disconnect the hose from the *YELLOW JACKET 68940* for storage.

2.5 Liquid Sampling

Liquid sampling is an option that is exclusive to the *YELLOW JACKET 68940*. It permits the user to flash liquid into vapor for introduction into the analyzer. To use the liquid sampling assembly, follow these eight steps:

- 1) Inspect the High Pressure Liquid Sample Trap Assembly and ensure that the plunger is completely depressed. Assemble the High Side Liquid Sample Hose as shown on page 1-12 of this manual.
- 2) Connect the appropriate end of the hose to the instrument and the opposite end of the liquid sampling assembly to the High Side Liquid port of the system or cylinder. Affix the High Pressure Liquid Sample Trap Assembly vertically to a tank with the magnet.
- 3) Open the high side valve of the cylinder. The liquid sample will exit the tank and flash to vapor in the hose assembly. As the liquid is flashed, the plunger on the High Pressure Liquid Sample Trap Assembly will begin to rise and the flashed refrigerant sample will travel into the analyzer.
- 4) Wait for the plunger on the High Pressure Liquid Sample Trap Assembly to expand past the outlet port.
- 5) Press 'TEST' on the Analyzer (**Figure 7**).
- 6) Upon completion of the test, close the valve on the cylinder, disconnect the hose from the inlet of the High Pressure Liquid Sample Trap Assembly, and depress the plunger to expel any trapped oil.
- 7) Inspect the hose for signs of oil and replace the Brass Sample Hose Restrictor if necessary.
- 8) Disconnect the hose from the *YELLOW JACKET 68940*.

NOTE: Liquid sampling will likely clog the Brass Sample Hose Restrictor much faster than Vapor Sampling. If the Restrictor becomes clogged and the analyzer continuously displays "Non-Condensable" or "Unknown Refrigerant" readings you will need to replace the clogged Restrictor with a new one. To avoid oil or liquid contamination from entering the analyzer, have a designated vapor and liquid Brass Sample Hose Restrictor for each form of testing.

2.6 Viewing the Test Results

Upon completion of the test, the *YELLOW JACKET 68940* will display a screen similar to that shown in (**Figure 9**). Pressing the 'MORE' button will display the screen shown in (**Figure 10**). Once you have completed your test, press 'DONE' to return back to the 'READY' screen (**Figure 7**) or refer to section **2.10 Print the Test Results & Channel Data** to print.

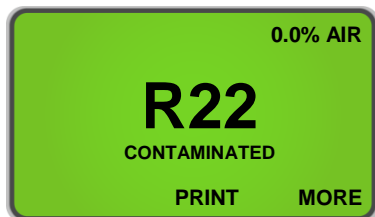

Figure 9

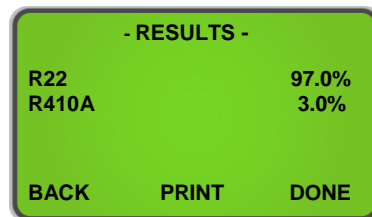

Figure 10

2.7 Contaminated Refrigerants

The *YELLOW JACKET 68940* includes the ability to detect and analyze the composition of many common R400 Series refrigerants in addition to **R22, R32, R134a** and **Hydrocarbons (HC)**. In the event that the *YELLOW JACKET 68940* determines that the primary refrigerant in the system or cylinder is one of the measured refrigerants, the results will display as follows in **(Figure 11)**. Pressing the 'MORE' button will display the detail screen shown in **(Figure 12)**. If the blend or refrigerant mixture is not recognized, the screen shown in **(Figure 13)** will be displayed. Refer to section **2.10 Print the Test Results & Channel Data** to print.

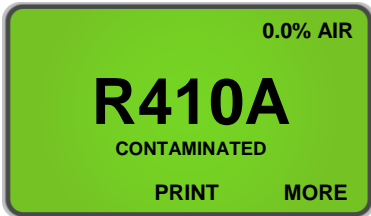

Figure 11

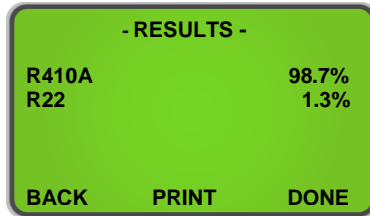

Figure 12

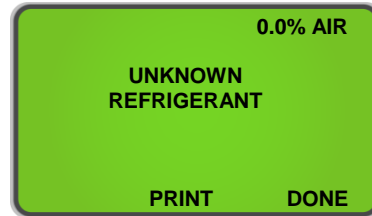

Figure 13

2.8 Pure Refrigerants

The *YELLOW JACKET 68940* has the ability to identify the following refrigerants: **R12, R1234yf, R408A, R409A, R417A, R421A, R421B, R422A, R422B, R422C, R427A** and **Hydrocarbons (HC)**. All identified refrigerants will display with "Purity Unknown" as the analyzer cannot yield additional information regarding the composition **(Figure 14)**. Refer to **2.12 Channel Data Modelling** for additional information regarding identified Refrigerants.

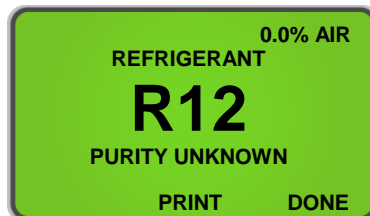

Figure 14

The instrument can also, Identify and Analyze the component content of pure **R134a, R22, HC (Hydrocarbons), R404A, R407C and R410A**. Analysis of analyzed pure blend refrigerants will yield additional data regarding the composition of the refrigerant sample. The *YELLOW JACKET 68940* will display the blend refrigerant type as shown in **(Figure 15)**. Pressing the 'MORE' button will display the detail screen shown in **(Figure 16)**. Refer to section **2.10 Print the Test Results & Channel Data** to print.

NOTE: Hydrocarbons (HC) encompass **R600, R600A and R290** and this machine cannot differentiate between Hydrocarbons.



Figure 15

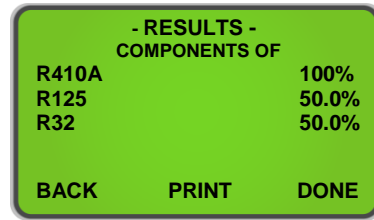

Figure 16

2.9 Pure Blends with Incorrect Component Ratios

The *YELLOW JACKET 68940* has the ability to detect blend ratios that have been altered by contamination. As stated in section **2.8 Pure Refrigerants**, the blends that can be *Identified and Analyzed* are **R22, R32, R134a, Hydrocarbons (HC), R404A, R407C and R410A**. If one of the multi-component refrigerant blends has incorrect component ratios, it will display as shown below in **(Figure 17)**. To see the component concentrations, press the 'MORE' button **(Figure 18)**. Refer to section **2.10 Print the Test Results & Channel Data** to print.

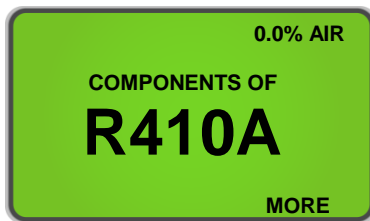

Figure 17

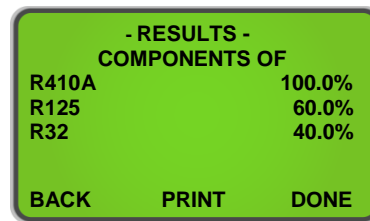

Figure 18

2.10 Measuring Air

The *YELLOW JACKET 68940* offers the ability to measure the presence of Air independently during every test. The built in oxygen sensor will display the percentage of Air in all *Identified* or *Identified and Analyzed* refrigerants if there is Air in a system or cylinder. The image below in **(Figure 19)** portrays how the LCD will display Air if detected. Pressing 'MORE' will display the purity of the refrigerants which were detected **(Figure 19a)**.

NOTE: Air is measured independently from refrigerant! You can have 100% pure refrigerant with a percentage of Air in a system or tank. The presence of Air will display on the initial results screen and on every printed test.

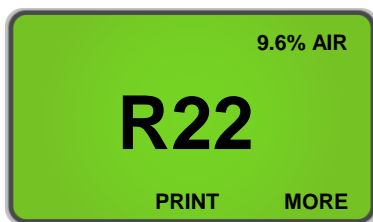

Figure 19

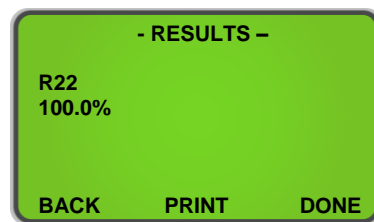

Figure 19a

2.11 Printing the Test Results & Channel Data

The Test Results and Channel Data can be printed after every test is completed. Pressing 'PRINT' on the bottom of the screen will print the test results for all Analyzed Refrigerants. The screen in **(Figure 20)** will display during printing. If printing Identified or 'Unknown Refrigerants", pressing 'PRINT' will allow you to print the Channel Data from the test. **(Figure 21)** will display during Channel Data printing.

Once printing is complete, carefully tear off the printout and press 'BACK' to return to the previous screen. Additional printouts may be made following the same procedure. To exit the test, press the 'DONE' button. **(Figures 22, 23, & 24)** show sample printouts for various test results.



Figure 20

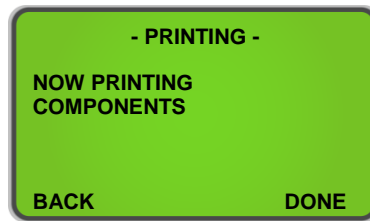

Figure 21

NOTE: Care must be taken when tearing off the printed results to leave a clean edge. Tear the paper from RIGHT to LEFT to avoid paper jams.

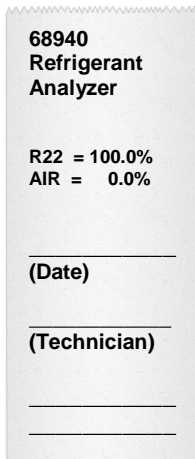

Figure 22

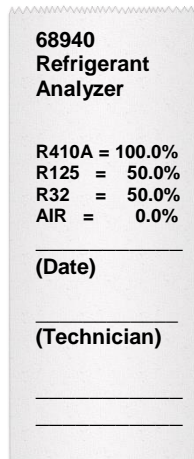

Figure 23

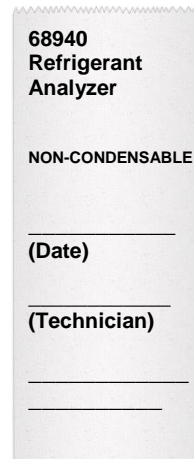

Figure 24

2.12 Channel Data Modelling

Channel Data Modelling is a unique feature to the *YELLOW JACKET 68940*. It allows the user to test refrigerants that the analyzer may not already identify and “fingerprint” the data using the available channels. The channel data is available for Identified and "Unknown Refrigerants."

Once you complete a test on an Identified Refrigerant (see list in section **2.8 Pure Refrigerants**) or "Unknown Refrigerants", the test results will display similar to **(Figure 25)** for Identified Refrigerants or **(Figure 25a)** for "Unknown Refrigerants." Once displayed, the analyzer will allow the user to print. Press the 'PRINT' button and the data will appear on the printout like **(Figure 26)**.

This new feature allows the user to develop a “fingerprint” model for different refrigerants the *YELLOW JACKET 68940* may not already analyze. If the user tests a virgin tank of refrigerant at least 3 times and receives Channel Data that is consistent or within a close range to one another, this data can be used as a “fingerprint” model of that particular refrigerant. This feature will allow the user to have a guide to identify refrigerants not already established by the analyzer and increases the capabilities of the *YELLOW JACKET 68940*.

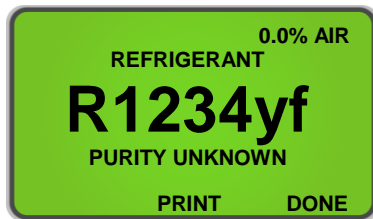

Figure 25

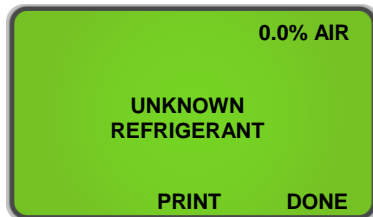

Figure 25a



Figure 26

NOTE: This is not a guaranteed method for identifying refrigerants. Results will vary and some refrigerants may create inconsistent data.

3

MAINTENANCE & TROUBLESHOOTING

3.1 Setting the LCD Contrast

The *YELLOW JACKET 68940* features an adjustable LCD contrast for use in varying light conditions. To adjust the contrast, press the 'SET' button which appears after the unit is powered on. The screen will display several options as shown in **(Figure 27)**. Pressing the 'SET' button will display the options in **(Figure 28)**. Press 'DOWN' or 'UP' to adjust the LCD contrast. Press 'SAVE' to save your settings and return the **(Figure 27)**.

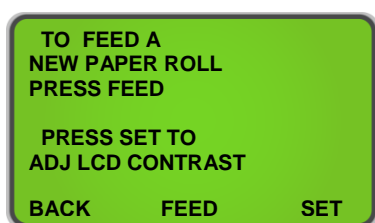

Figure 27

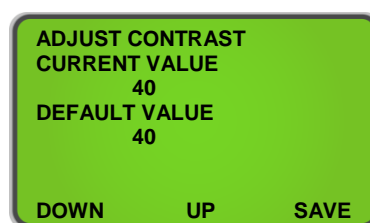

Figure 28

3.2 Changing the White Plastic Sample Filter

When inspecting the sample filter, look completely around the entire outside diameter of the white filter element located inside of the clear plastic housing. Look for red spots or the beginnings of discoloration on the white outside diameter of the element. *DO NOT* look into the round ends of the white element for red spots or discoloration. The round ends of the filter may always appear red. If red spots or discolorations are discovered on the outside diameter, the sample filter requires replacement to prevent the influx of particulate and oil mists into the instrument.

To change the Sample Filter, first obtain a replacement filter. Remove the existing filter from the retaining clip of the instrument by pulling straight up and out. *CAREFULLY* remove the flexible, black rubber tubing connections from both ends of the existing filter. *DO NOT* allow the tubes to slip back into the internal portion of the case. Discard the existing filter in an environmentally friendly manner.

Install the tube ends onto the barbs of the replacement filter, taking note to align the flow arrow of the filter with the flow arrow on the analyzers top panel. *CAREFULLY* slide the tubing back into the internal portion of the instrument and seat the new filter into the retaining clip. Inspect your hose assemblies for signs of oil entrapment. Replacement of the Sample Filter usually requires replacement of the Brass Sample Hose Restrictor Assembly.

3.3 Replacing the Brass Sample Hose Restrictor

In either Vapor Sampling or Liquid Sampling mode always inspect the inside diameter of the tube for signs of oil build up, dirt, obstructions, kinks, cuts, fraying, or any other signs of wear before use. Oil contamination cannot be cleaned out of sample hoses due to the density of the brass oil restrictor. If oil is visible in the hose assembly, replace the Brass Sample Hose Restrictor Assembly.

NOTE: The analyzer will indicate “Non-Condensable” or “Unknown Refrigerant” if the analyzer does not receive a good sample due to obstructed flow or lack of flow (approximately less than 30 psig or 2 Bar). If this occurs the Brass Sample Hose Restrictor may need to be replaced.

To replace the Restrictor Assembly, follow the instructions below:

- 1) Disconnect the sample hose from the Analyzer
- 2) Remove the brass restrictor (with hose attached) from the coupler and discard. Be sure to use a backing wrench as not to damage the coupler.
- 3) Check for signs of oil and debris in the coupler.
- 4) Using “CRC Brakleen” or similar cleaner which ONLY contains, Tetrachloroethylene and carbon dioxide, follow safety instructions on the can and spray all parts of the coupler with the cleaner to remove the oil. DO NOT soak the parts for more than 60 seconds.
- 5) Allow coupler parts to dry. Check coupler parts for oil once again. Failure to clean the oil out of the coupler will result in premature clogging of the new filter.
- 6) Install the Brass Sample Hose Restrictor into the coupler and lightly tighten, usually finger tight is sufficient.

3.4 Changing the Printer Paper

All *YELLOW JACKET 68940* Refrigerant Analyzer is equipped with on-board printer that uses an inexpensive thermal paper for printing. The paper roll should be changed when a red stripe appears on the left side of the printout.

To change the paper roll, press the ‘SET’ button shortly after powering the analyzer on or any time it appears. The screen will display several options as shown in **(Figure 29)**. Press the ‘FEED’ button to advance to the screen shown in **(Figure 30)**.

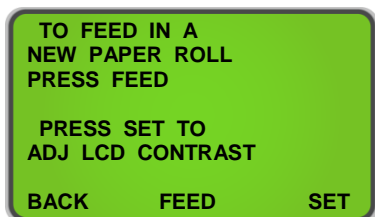

Figure 29

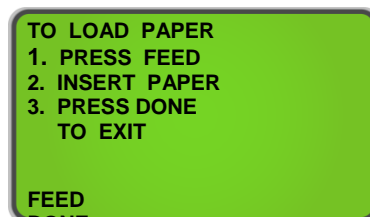

Figure 30

Open the printer door and remove the old roll by tearing the paper as it enters the printer then pressing the 'FEED' button shown in **(Figure 30)** until the old roll exits the printer completely. Insert the new paper roll from the underside as shown below:



Press the 'FEED' button shown in **(Figure 30)** to automatically advance the paper through the printer. Allow at least 3 in (7cm) of paper to exit the top of the printer. Press the 'DONE' button to stop the printer from advancing the paper. This will take you back to **(Figure 29)**. Slide the paper through the slot in the printer door and close the door.

3.5 Software Updates

From time to time, software updates may be made available to improve operating performance or add additional features. Some updates will be provided at no charge to implement operating efficiencies while others will be optional, paid upgrades, to add new refrigerants etc. Many of the updates can be completed by the user; however some will require the instrument to be returned to the factory for new gas calibrations.

The *YELLOW JACKET 68940* has a USB update port located on the Back Panel Connections. This port should not be used for any other purpose other than to install factory updates. **IF YOU DO NOT REGISTER THE ANALYZER WE WILL NOT BE ABLE TO INFORM YOU OF ANY SOFTWARE UPDATES!**

3.6 Low Battery Warning

A battery warning will occur when the internal Lithium Iron Phosphate battery voltage becomes low (**Figure 31**). You can either continue working or connect the 12V AC Power Supply and continue to work by pressing 'IGNORE'. The analyzer will charge the battery while it is connected to the AC Power Supply but if you wish to use it wirelessly press 'OFF', plug the analyzer into the AC Power Supply via the 12DC Outlet Input on the Back Panel and allow it to fully charge. Full charge will take at least 2 hours.

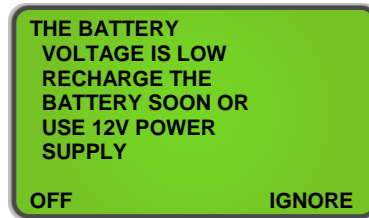

Figure 31

3.7 Air Sensor Low

In the event you receive an 'Air Sensor Low' message like (**Figure 32**) there is no need to discontinue use. This message is meant to alert you that the built-in oxygen sensor is depleting and will need to be replaced in the near future. If the analyzer you are using is new and you believe you received this message in fault, first verify gas is not flowing into the analyzer and that you are in a well-ventilated area. Once you have verified both, press 'RECAL' to recalibrate the analyzer. If you have had the analyzer for a few years the oxygen sensor may be near depletion. Pressing 'TEST' allows you to bypass the message and finish your testing. The oxygen sensor is a consumable part and will eventually need to be replaced. After receiving this message plan on contacting Ritchie Engineering to schedule a service appointment.

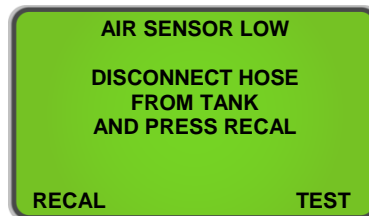

Figure 32

3.8 Error Messages

In the unlikely event that an "Error" message is displayed on the screen, power off the unit, take it to a location outside of the shop environment where fresh air is available and turn the unit back on. If the "Error" message reappears, refer to the help screens on the instrument or contact our service department for assistance.

Ritchie Engineering – YELLOW JACKET Products Division
10950 Hampshire Avenue South
Bloomington, MN 55438, USA
Tel: (952) 943-1300

Contact us: custserv@yellowjacket.com

APPENDICES

3.9 Spare Parts List

| PART NUMBER | DESCRIPTION |
|-------------|--|
| 68948 | Optional internal rechargeable battery kit with battery and 110V charger |
| 68949 | Optional 110/220V power adapter |
| 68950 | Thermal printer paper – 1 roll |
| 68977 | In line identifier replacement filter |
| 68978 | R-12 replacement hose |
| 68979 | R-134a replacement hose |
| 68994 | Replacement flow restrictor hose (3 pak) |

3.10 Appendix B - Specifications

| | |
|--|--|
| SAMPLE PARAMETERS: | Vapor or Liquid, oil-free, 500 psig Maximum |
| CONTAMINATE SENSITIVITY: | Contaminate sensitivity filter is enabled by default. Contact factory to disable. |
| IDENTIFIED REFRIGERANTS: | R12, R1234yf, R408A, R409A, R417A*, R421A*, R421B, R422A, R422B, R422C, R427A, HC (Hydrocarbons) * Due to similar formulas, R417A and R421A may be identified as either R417A or R421A |
| IDENTIFIED & ANALYZED REFRIGERANTS: | R22, R32, R134a, R404A, R407C, R410A, HC (Hydrocarbons) |
| SENSOR TECHNOLOGY: | Non-Dispersive Infrared (NDIR) |
| REFRIGERANT SAMPLE SIZE: | 0.3 ounces (8.5 grams) per sample |
| POWER: | Power Supply: Input: 90-264VAC, 50-60HZ Output: 12 VDC, 2.0 AMP Built in Lithium Iron Phosphate Battery: LiFE 2100mAh |
| ENVIRONMENTAL CONDITIONS | Do not expose unit or external components to rain or moisture. Humidity: 0 to 95% RH non-condensing. Protect Unit from physical abuse by keeping the unit in the storage case when not in use. |
| OPERATIONAL TEMPERATURE: | 50-120°F (10-49°C) |